

Two-Channel SATA 6-Gb/s Redriver

Check for Samples: [SN75LVCP601](#)

FEATURES

- 1.5/3/6-Gbps Two-Channel Redriver
- Integrated Output Squelch
- Programmable Rx/Tx Equalization and De-Emphasis Width Control
- Power-Save Feature Lowers Power by >80% in Auto Low-Power Mode
- Low Power
 - <220 mW Typ
 - <50 mW (in Auto Low-Power Mode)
 - <5m W (in Standby Mode)
- Excellent Jitter and Loss Compensation Capability to Over 24-Inch (61-cm) FR4 Trace

- 20-Pin 4 × 4 QFN Package
- High Protection Against ESD Transient
 - HBM: 10,000 V
 - CDM: 1,500 V
 - MM: 200 V
- Pin-Compatible to LVCP412A/MAX4951

APPLICATIONS

- Notebooks, Desktops, Docking Stations, Servers, and Workstations

DESCRIPTION

SN75LVCP601 is a dual-channel, single-lane SATA redriver and signal conditioner supporting data rates up to 6 Gbps. The device complies with SATA physical link 2m and 3i specifications. SN75LVCP601 operates from a single 3.3-V supply and has 100-Ω line termination with a self-biasing feature, making the device suitable for ac coupling. The inputs incorporate an out-of-band (OOB) detector, which automatically squelches the output while maintaining a stable common-mode voltage compliant to the SATA link. The device is also designed to handle spread-spectrum clocking (SSC) transmission per the SATA specification.

The SN75LVCP601 handles interconnect losses at both its input and output. The input stage of each channel offers selectable equalization settings that can be programmed to match the loss in the channel. The differential outputs provide selectable de-emphasis to compensate for the distortion that the SATA signal is expected to experience. The level of equalization and de-emphasis settings depends on the length of interconnect and its characteristics. Both equalization and de-emphasis levels are controlled by the setting of signal control pins EQ1, EQ2, DE1, and DE2.

The device is hot-plug capable (requires the use of ac-coupling capacitors at differential inputs and outputs), preventing device damage under device *hot*-insertion, such as async signal plug/removal, unpowered plug/removal, powered plug/removal, or surprise plug/removal.

ORDERING INFORMATION⁽¹⁾

PART NUMBER	PART MARKING	PACKAGE
SN75LVCP601RTJR	LVC601	20-pin RTJ, reel (large)
SN75LVCP601RTJT	LVC601	20-pin RTJ, reel (small)

(1) For the most current package and ordering information, see the Package Option Addendum at the end of this document, or see the TI Web site at www.ti.com.



Please be aware that an important notice concerning availability, standard warranty, and use in critical applications of Texas Instruments semiconductor products and disclaimers thereto appears at the end of this data sheet.



These devices have limited built-in ESD protection. The leads should be shorted together or the device placed in conductive foam during storage or handling to prevent electrostatic damage to the MOS gates.

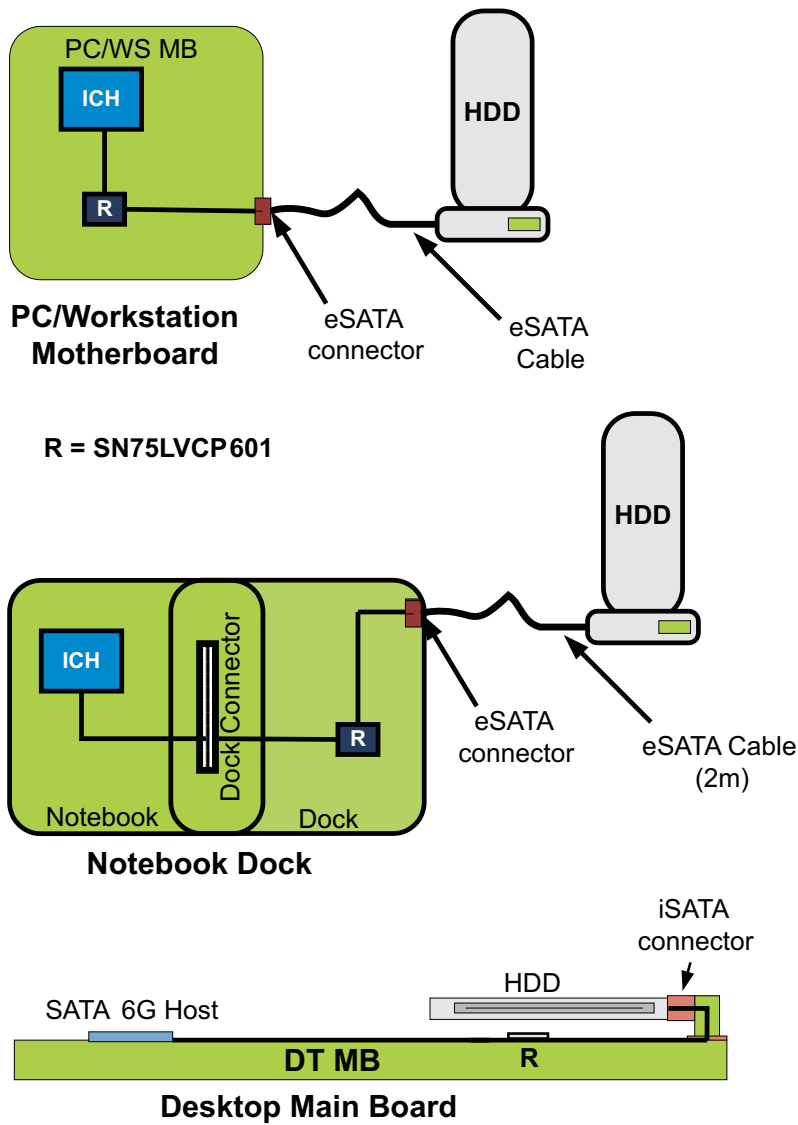

Figure 1. Typical Application

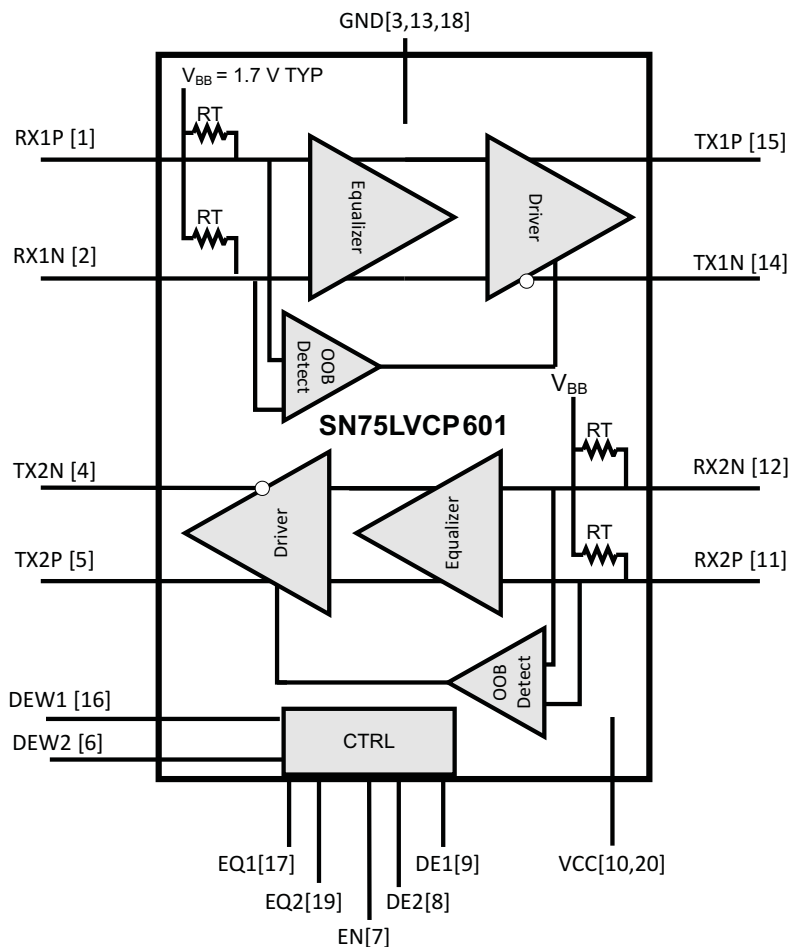

Figure 2. Data Flow Block Diagram

PIN TABLE

NAME	PIN	DESCRIPTION	NAME	PIN	DESCRIPTION
RX1P	1	Input 1, non-inverting	RX2P	11	Input 2, non-inverting
RX1N	2	Input 1, inverting	RX2N	12	Input 2, inverting
GND	3	Ground	GND	13	Ground
TX2N	4	Output 2, inverting	TX1N	14	Output 1, inverting
TX2P	5	Output 2, non-inverting	TX1P	15	Output 1, non-inverting
DEW2 ⁽¹⁾	6	De-emphasis width cntrl.-CH 2	DEW1 ⁽¹⁾	16	De-emphasis width cntrl.-CH 1
EN ⁽¹⁾	7	Enable	EQ1 ⁽²⁾	17	EQ control CH 1
DE2 ⁽²⁾	8	De-emphasis CH2	GND	18	Ground
DE1 ⁽²⁾	9	De-emphasis CH1	EQ2 ⁽²⁾	19	EQ control CH 2
Vcc	10	3.3-V supply	Vcc	20	3.3-V supply

(1) DEW1/2, EN tied to Vcc via internal PU resistor
 (2) DE1, DE2, EQ1, EQ2 are tied to Vcc/2 via internal resistor

PACKAGE PINOUT

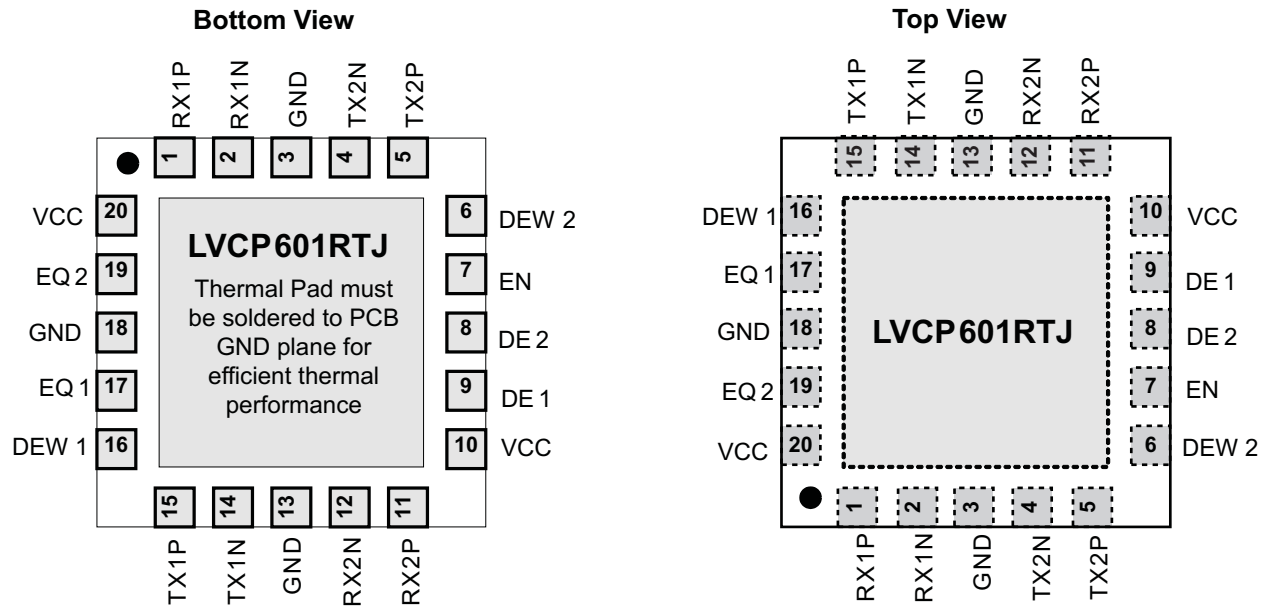

PIN FUNCTIONS

PIN		PIN TYPE	DESCRIPTION
NO.	NAME		
HIGH-SPEED DIFFERENTIAL I/O			
2	RX1N	I, CML	Non-inverting and inverting CML differential input for CH 1 and CH 2. These pins are tied to an internal voltage bias by a dual-termination resistor circuit.
1	RX1P	I, CML	
12	RX2N	I, CML	
11	RX2P	I, CML	Non-inverting and inverting CML differential output for CH 1 and CH 2. These pins are internally tied to voltage bias by termination resistors.
14	TX1N	O, CML	
15	TX1P	O, CML	
4	TX2N	O, CML	
5	TX2P	O, CML	
CONTROL PINS			
4	EN	I, LVCMOS	Device enable/disable pin, internally pulled to Vcc. See Table 2 .
8, 9	DE1, DE2 ⁽¹⁾	I, LVCMOS	Selects de-emphasis settings for CH 1 and CH 2 per Table 1 . Internally tied to Vcc/2
17, 19	EQ1, EQ2 ⁽¹⁾	I, LVCMOS	Selects equalization settings for CH 1 and CH 2 per Table 1 . Internally tied to Vcc/2
16, 6	DEW1, DEW2	I, LVCMOS	De-emphasis width control for CH 1 and CH 2. See Table 2 .
POWER			
10, 20	Vcc	Power	Positive supply should be 3.3 V ± 10%.
3, 13, 18	GND	Power	Supply ground

- (1) Internally biased to Vcc/2 with >200-kΩ pullup/pulldown. When 3-state pins are left as NC, board leakage at the pin pad must be <1 μA; otherwise, drive to Vcc/2 to assert mid-level state.

Table 1. Tx/Rx EQ and DE Pulse-Duration Settings

DE1/DE2	CH1/CH2De-Emphasis dB (at 6Gbps)	EQ1/EQ2	CH1/CH2Equalization dB (at 6Gbps)
NC (<i>default</i>)	-4	NC (<i>default</i>)	0
0	0	0	7
1	-2	1	14
DEW1/DEW2	Device Function → DE Width for CH1/CH2		
0	De-emphasis pulse duration, short (recommended setting when link operates at SATA 1.5/3/6 Gbps)		
1 (<i>default</i>)	De-emphasis pulse duration, long (recommended setting when link operates at SATA 1.5/3 Gbps speed only)		

Table 2. Control Pin Settings

EN	Device Function → Standby Mode
0	Device in standby mode
1 (<i>default</i>)	Device enabled

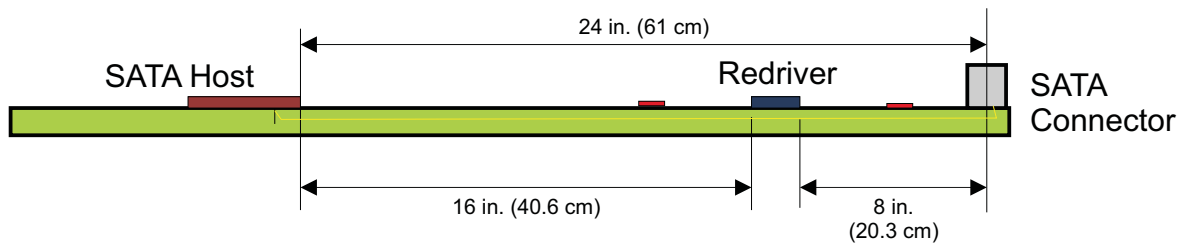

Redriver on Motherboard

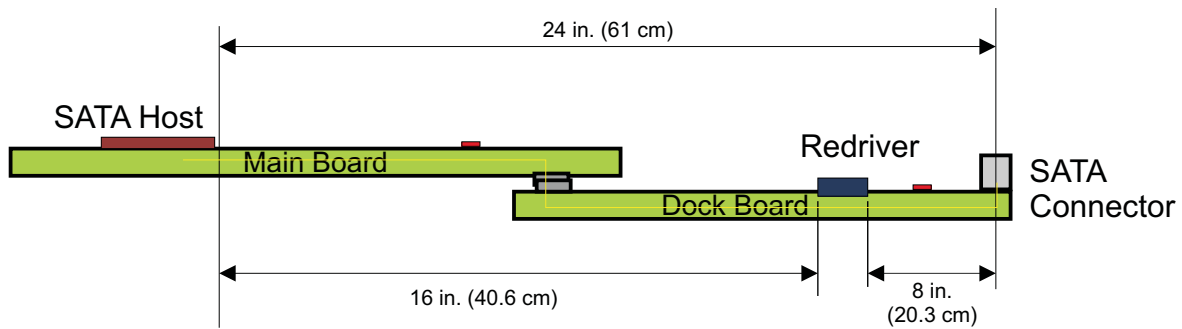

Redriver on Dock Board

NOTE: *Trace lengths are suggested values based on TI spice simulations (done over programmable limits of input EQ and output de-emphasis) to meet SATA loss and jitter spec.

Actual trace length supported by the LVCP601 may be more or less than suggested values and depends on board layout, trace widths, and number of connectors used in the SATA signal path.

Figure 3. Trace Length Example* for LVCP601

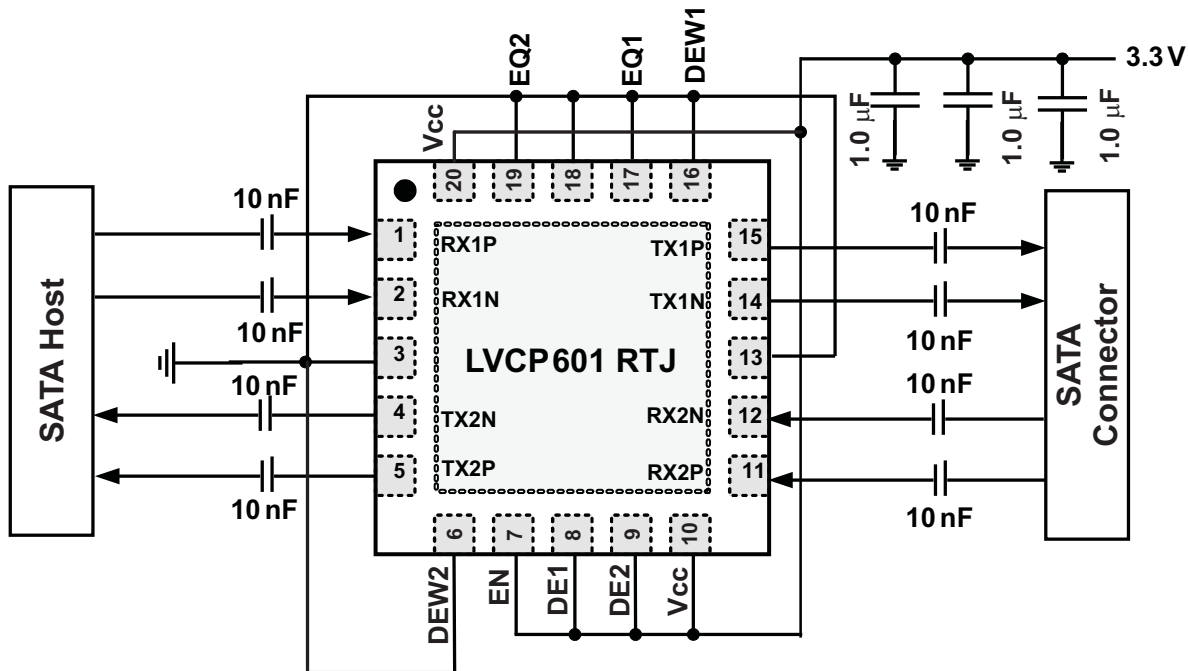

- (1) Place supply capacitors close to device pin.
- (2) EN can be left open or tied to supply when no external control is implemented.
- (3) Output de-emphasis selection is set at -2 dB, EQ at 7 dB, and DE duration for SATA I/II/III operation for both channels.
- (4) Actual EQ/DE duration settings depend on device placement relative to host and SATA connector.

Figure 4. Typical Device Implementation

OPERATION DESCRIPTION

INPUT EQUALIZATION

Each differential input of the SN75LVCP601 has programmable equalization in its front stage. The equalization setting is shown in [Table 1](#). The input equalizer is designed to recover a signal even when no eye is present at the receiver, and effectively supports FR4 trace at the input anywhere from 4 in. (10.2 cm) to 20 in. (50.8 cm) at SATA 6G speed.

OUTPUT DE-EMPHASIS

The SN75LVCP601 provides the de-emphasis settings shown in [Table 1](#). De-emphasis is controlled independently for each channel, and is set by the control pins DE1 and DE2 as shown in [Table 1](#). There are two de-emphasis duration settings available in the device. DEW1 and DEW2 control the DE durations for channels one and two, respectively. The recommended settings for these control pins are listed [Table 1](#). Output de-emphasis is capable of supporting FR4 trace at the output anywhere from 2 in. (5.1 cm) to 12 in. (30.5 cm) at SATA 3G/6G speed.

LOW-POWER MODE

Two low-power modes are supported by the SN75LVCP601, listed as follows:

1. Standby mode (triggered by the EN pin, EN = 0 V)
 - Low-power mode is controlled by the enable (EN) pin. In its default state, this pin is internally pulled high. Pulling this pin LOW puts the device in standby mode within 2 μ s (max). In this mode, all active components of the device are driven to their quiescent level, and differential outputs are driven to Hi-Z (open). Maximum power dissipation in this mode is 5 mW. Exiting from this mode to normal operation requires a maximum latency of 5 μ s.

2. Auto low-power mode (triggered when a given channel is in the electrically idle state for more than 100 μ s and EN = Vcc)
 - The device enters and exits low-power mode by actively monitoring the input signal (VIDp-p) level on each of its channels independently. When the input signal on either or both channels is in the electrically idle state, i.e., VIDp-p < 50 mV and stays in this state for >100 μ s, the associated channel(s) enters into the low-power state. In this state, output of the associated channel(s) is driven to VCM and the device selectively shuts off some circuitry to lower power by >80% of its normal operating power. Exit time from the auto low-power mode is <50 ns.

Out-of-Band (OOB) SUPPORT

The squelch detector circuit within the device enables full detection of OOB signaling as specified in the SATA specification. Differential signal amplitude at the receiver input of 50 mVpp or less is not detected as an activity and hence not passed to the output. Differential signal amplitude of 150 mVp-p or more is detected as an activity and therefore passed to the output, indicating activity. Squelch circuit ON/OFF time is 5 ns, maximum. While in squelch mode, outputs are held to VCM.

DEVICE POWER

The SN75LVCP601 is designed to operate from a single 3.3 V supply. Always practice proper power-supply sequencing procedure. Apply Vcc first, before any input signals are applied to the device. The power-down sequence is in reverse order.

ABSOLUTE MAXIMUM RATINGS

over operating free-air temperature range (unless otherwise noted) ⁽¹⁾

		VALUE	UNIT
Supply voltage range ⁽²⁾	V _{CC}	–0.5 to 4	V
Voltage range	Differential I/O	–0.5 to 4	V
	Control I/O	–0.5 to V _{CC} + 0.5	V
Electrostatic discharge	Human-body model ⁽³⁾	±10,000	V
	Charged-device model ⁽⁴⁾	±1500	V
	Machine model ⁽⁵⁾	±200	V
Continuous power dissipation		See Thermal Table	

- (1) Stresses beyond those listed under *Absolute Maximum Ratings* may cause permanent damage to the device. These are stress ratings only, and functional operation of the device at these or any conditions beyond those indicated under *Recommended Operating Conditions* is not implied. Exposure to absolute-maximum-rated conditions for extended periods may affect device reliability.
- (2) All voltage values, except differential voltages, are with respect to the network ground terminal.
- (3) Tested in accordance with JEDEC Standard 22, Test Method A114-B.
- (4) Tested in accordance with JEDEC Standard 22, Test Method C101-A.
- (5) Tested in accordance with JEDEC Standard 22, Test Method A115-A.

THERMAL INFORMATION

THERMAL METRIC ⁽¹⁾		SN75LVCP601	UNITS
		QFN	
		20 PINS	
θ_{JA}	Junction-to-ambient thermal resistance ⁽²⁾	38	°C/W
θ_{JCTop}	Junction-to-case (top) thermal resistance ⁽³⁾	40	°C/W
θ_{JB}	Junction-to-board thermal resistance ⁽⁴⁾	10	°C/W

- (1) For more information about traditional and new thermal metrics, see the *IC Package Thermal Metrics* application report, [SPRA953](#).
- (2) The junction-to-ambient thermal resistance under natural convection is obtained in a simulation on a JEDEC-standard, high-K board, as specified in JESD51-7, in an environment described in JESD51-2a.
- (3) The junction-to-case (top) thermal resistance is obtained by simulating a cold plate test on the package top. No specific JEDEC-standard test exists, but a close description can be found in the ANSI SEMI standard G30-88.
- (4) The junction-to-board thermal resistance is obtained by simulating in an environment with a ring cold plate fixture to control the PCB temperature, as described in JESD51-8.

THERMAL INFORMATION (continued)

THERMAL METRIC ⁽¹⁾		SN75LVCP601	UNITS
		QFN	
		20 PINS	
Ψ_{JT}	Junction-to-top characterization parameter ⁽⁵⁾	0.5	°C/W
Ψ_{JB}	Junction-to-board characterization parameter ⁽⁶⁾	0.9	°C/W
θ_{JCbot}	Junction-to-case (bottom) thermal resistance ⁽⁷⁾	15.2	°C/W
P_D	Device power dissipation in active mode	215 to 288	mW
P_{SD}	Device power dissipation under standby mode	5	mW

- (5) The junction-to-top characterization parameter, Ψ_{JT} , estimates the junction temperature of a device in a real system and is extracted from the simulation data for obtaining θ_{JA} , using a procedure described in JESD51-2a (sections 6 and 7).
- (6) The junction-to-board characterization parameter, Ψ_{JB} , estimates the junction temperature of a device in a real system and is extracted from the simulation data for obtaining θ_{JA} , using a procedure described in JESD51-2a (sections 6 and 7).
- (7) The junction-to-case (bottom) thermal resistance is obtained by simulating a cold plate test on the exposed (power) pad. No specific JEDEC standard test exists, but a close description can be found in the ANSI SEMI standard G30-88.

RECOMMENDED OPERATING CONDITIONS

(Typical values for all parameters are at $V_{CC} = 3.3V$ and $T_A = 25^\circ C$. All temp limits are specified by design)

PARAMETER		CONDITIONS	MIN	TYP	MAX	UNITS
V_{CC}	Supply voltage		3	3.3	3.6	V
$C_{COUPLING}$	Coupling capacitor			12		nF
	Operating free-air temperature		0		85	°C

ELECTRICAL CHARACTERISTICS

over operating free-air temperature range (unless otherwise noted)

PARAMETER		TEST CONDITIONS	MIN	TYP	MAX	UNIT
DEVICE PARAMETERS						
P_D	Power dissipation in active mode	DEWx = EN = V _{CC} , EQx = DEx = NC, K28.5 pattern at 6 Gbps, V _{ID} = 700 mV _{p-p}		215	288	mW
P_{SD}	Power dissipation in standby mode	EN = 0 V, DEWx = EQx = DEx = NC, K28.5 pattern at 6 Gbps, V _{ID} = 700 mV _{p-p}			5	mW
I_{CC}	Active-mode supply current	EN = 3.3 V, DEWx = 0 V, EQx/DEx = NC, K28.5 pattern at 6 Gbps, V _{ID} = 700 mV _{p-p}		65	80	mA
I_{CC_ALP}	Active power-save mode I _{CC}	When device is enabled and auto low-power conditions are met		6.5	10	mA
I_{CC_STDBY}	Standby mode supply current	EN = 0 V			1	mA
	Maximum data rate			1	6	Gbps
t_{PDelay}	Propagation delay	Measured using K28.5 pattern. See Figure 8 .		323	400	ps
AutoLP _{ENTRY}	Auto low-power entry time	Electrical idle at input; see Figure 9 .	80	105	130	μs
AutoLP _{EXIT}	Auto low-power exit time	After first signal activity; see Figure 9 .		42	50	ns
t_{ENB}	Device enable time	EN 0→1			5	μs
t_{DIS}	Device disable time	EN 1→0			2	μs

ELECTRICAL CHARACTERISTICS (continued)

over operating free-air temperature range (unless otherwise noted)

PARAMETER		TEST CONDITIONS	MIN	TYP	MAX	UNIT
OUT-OF-BAND (OOB)						
V _{OOB}	Input OOB threshold	f = 750 MHz	50	78	150	mVpp
D _{VdiffOOB}	OOB differential delta				25	mV
D _{VCMOOB}	OOB common-mode delta				50	mV
t _{OOB1}	OOB mode enter	See Figure 9 .		3	5	ns
t _{OOB2}	OOB mode exit			3	5	ns
CONTROL LOGIC						
V _{IH}	Input high voltage	For all control pins	1.4			V
V _{IL}	Input low voltage				0.5	V
V _{INHYS}	Input hysteresis			115		mV
I _{IH}	High-level input current	EQx, DEx = V _{CC}			30	μA
		EN, DEWx = V _{CC}			1	
I _{IL}	Low-level input current	EQx, DEx = GND	-30			μA
		EN, DEWx = GND	-10			
RECEIVER AC/DC						
Z _{DIFFRX}	Differential-input impedance		85	100	115	Ω
Z _{SERX}	Single-ended input impedance		40			Ω
V _{CMRX}	Common-mode voltage			1.8		V
R _{LDiffRX}	Differential-mode return loss (RL)	f = 150 MHz–300 MHz	18	28		dB
		f = 300 MHz–600 MHz	14	17		
		f = 600 MHz–1.2 GHz	10	12		
		f = 1.2 GHz–2.4 GHz	8	9		
		f = 2.4 GHz–3 GHz	3	9		
R _{XDiffRLSlope}	Differential-mode RL slope	f = 300 MHz–6 GHz (See Figure 5 .)		-13		dB/dec
R _{LCMRX}	Common-mode return loss	f = 150 MHz–300 MHz	5	10		dB
		f = 300 MHz–600 MHz	5	17		
		f = 600 MHz–1.2 GHz	2	23		
		f = 1.2 GHz–2.4 GHz	1	16		
		f = 2.4 GHz–3 GHz	1	12		
V _{diffRX}	Differential input voltage PP	f = 1.5 GHz and 3 GHz	120		1600	mVppd
I _{B_{RX}}	Impedance balance	f = 150 MHz–300 MHz	30	41		dB
		f = 300 MHz–600 MHz	30	38		
		f = 600 MHz–1.2 GHz	20	32		
		f = 1.2 GHz–2.4 GHz	10	26		
		f = 2.4 GHz–3 GHz	10	25		
		f = 3 GHz–5 GHz	4	20		
		f = 5 GHz–6.5 GHz	4	17		
t _{20-80RX}	Rise/fall time	Rise times and fall times measured between 20% and 80% of the signal. SATA 6-Gbps speed measured 1 in, (2.5 cm) from device pin	62		75	ps
t _{skewRX}	Differential skew	Difference between the single-ended midpoint of the RX+ signal rising/falling edge, and the single-ended midpoint of the RX- signal falling/rising edge			30	ps

ELECTRICAL CHARACTERISTICS (continued)

over operating free-air temperature range (unless otherwise noted)

PARAMETER		TEST CONDITIONS	MIN	TYP	MAX	UNIT
TRANSMITTER AC/DC						
Z_{diffTX}	Pair differential impedance		85	100	122	Ω
Z_{SETX}	Single-ended impedance		40			Ω
$V_{TXtrans}$	Sequencing transient voltage	Transient voltages on the serial data bus during power sequencing (lab load)	-1.2		1.2	V
RL_{DiffTX}	Differential-mode return loss	f = 150 MHz–300 MHz	14	24		dB
		f = 300 MHz–600 MHz	8	19		
		f = 600 MHz–1.2 GHz	6	14		
		f = 1.2 GHz–2.4 GHz	6	10		
		f = 2.4 GHz–3 GHz	3	10		
$TX_{DiffRLSlope}$	Differential-mode RL slope	f = 300 MHz–3 GHz (See Figure 5.)		-13		dB/dec
RL_{CMTX}	Common-mode return loss	f = 150 MHz–300 MHz	5	20		dB
		f = 300 MHz–600 MHz	5	19		
		f = 600 MHz–1.2 GHz	2	17		
		f = 1.2 GHz–2.4 GHz	1	12		
		f = 2.4 GHz–3.0 GHz	1	11		
IB_{TX}	Impedance balance	f = 150 MHz–300 MHz	30	41		dB
		f = 300 MHz–600 MHz	30	38		
		f = 600 MHz–1.2 GHz	20	33		
		f = 1.2 GHz–2.4 GHz	10	24		
		f = 2.4 GHz–3 GHz	10	26		
		f = 3 GHz–5 GHz	4	22		
		f = 5 GHz–6.5 GHz	4	21		
$DiffV_{ppTX}$	Differential output-voltage swing	f = 3 GHz, DE1/DE2 = 0, DEWx = NC, (under no interconnect loss)		550		mVppd
DE	Output de-emphasis	f = 3 GHz, DE1/DE2 = 0		0		dB
		f = 3 GHz, DE1/DE2 = 1		-2		
		f = 3 GHz, DE1/DE2 = NC		-4		
t_{DE}	De-emphasis duration	DEWx = 0		94		ps
		DEWx = 1		215		
VCM_{AC_TX}	TX AC CM voltage	At 1.5 GHz		20	50	mVppd
		At 3 GHz		12	26	
		At 6 GHz		13	30	
VCM_{TX}	Common-mode voltage			1.8		V
$t_{20-80TX}$	Rise/fall time	Rise times and fall times measured between 20% and 80% of the signal. At 6Gbps under no load conditions	42	55	75	ps
t_{skewTX}	Differential skew	Difference between the single-ended mid-point of the TX+ signal rising/falling edge, and the single-ended mid-point of the TX- signal falling/rising edge.		6	20	ps
TxR/F_{imb}	TX rise-fall imbalance	At 3 Gbps		6%	20%	
$TxAmp_{imb}$	TX amplitude imbalance			2%	10%	

ELECTRICAL CHARACTERISTICS (continued)

over operating free-air temperature range (unless otherwise noted)

PARAMETER		TEST CONDITIONS	MIN	TYP	MAX	UNIT
TRANSMITTER JITTER						
DJ _{TX}	Deterministic jitter ⁽¹⁾ at CP in Figure 6	VID = 500 mVpp, UI = 333 ps, K28.5 control character		0.06	0.19	UIp-p
RJ _{TX}	Residual random jitter ⁽¹⁾	VID = 500 mVpp, UI = 333 ps, K28.7 control character		0.01	2	ps-rms
DJ _{TX}	Deterministic jitter ⁽¹⁾ at CP in Figure 6	VID = 500 mVpp, UI = 167 ps, K28.5 control character		0.08	0.34	UIp-p
RJ _{TX}	Residual random jitter ⁽¹⁾	VID = 500 mVpp, UI = 167 ps, K28.7 control character		0.09	2	ps-rms

(1) $TJ = (14.1 \times RJ_{SD} + DJ)$, where RJ_{SD} is one standard deviation value of RJ Gaussian distribution. Jitter measurement is at the SATA connector and includes jitter generated at the package connection on the printed circuit board, and at the board interconnect as shown in .

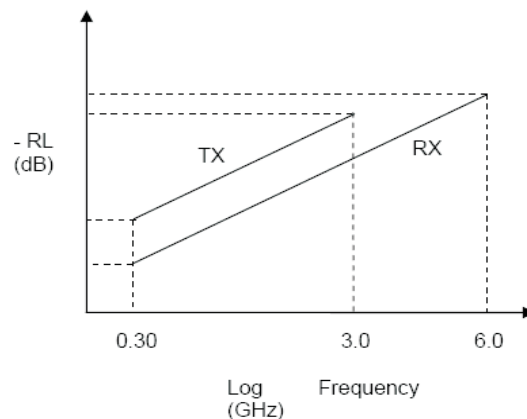

Figure 5. TX, RX Differential Return Loss Limits

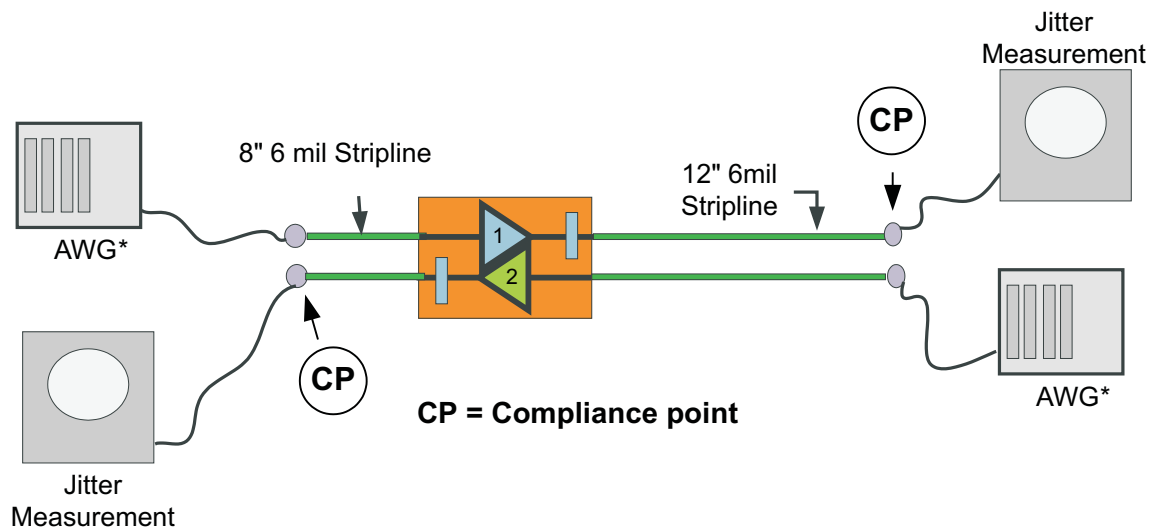

Figure 6. Jitter Measurement Test Condition

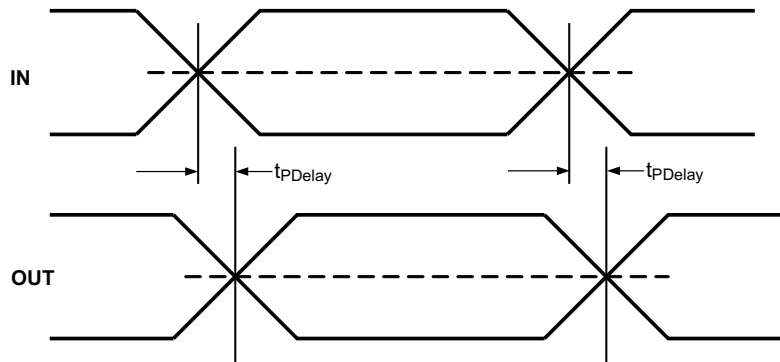

Figure 7. Propagation Delay Timing Diagram

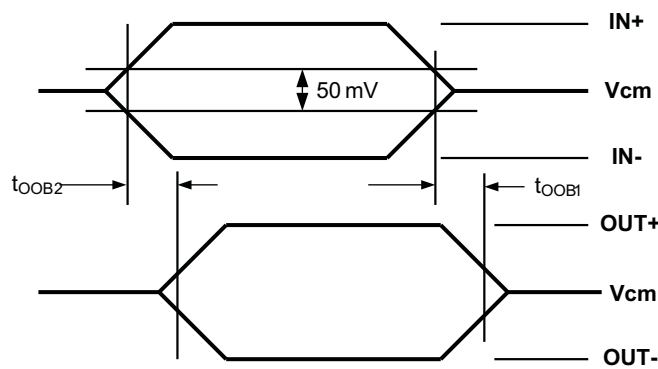

Figure 8. OOB Enter and Exit Timing

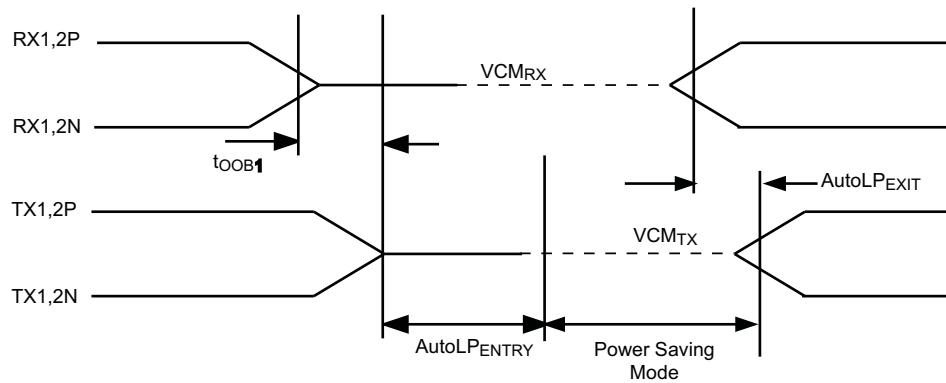

Figure 9. Auto Low-Power Mode Enter and Exit Timing

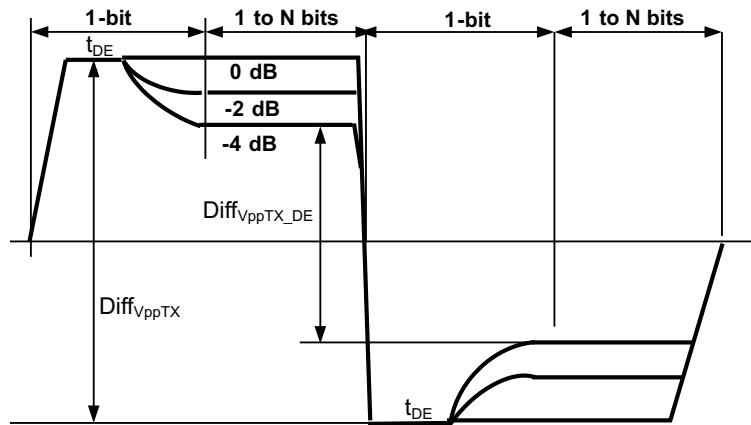
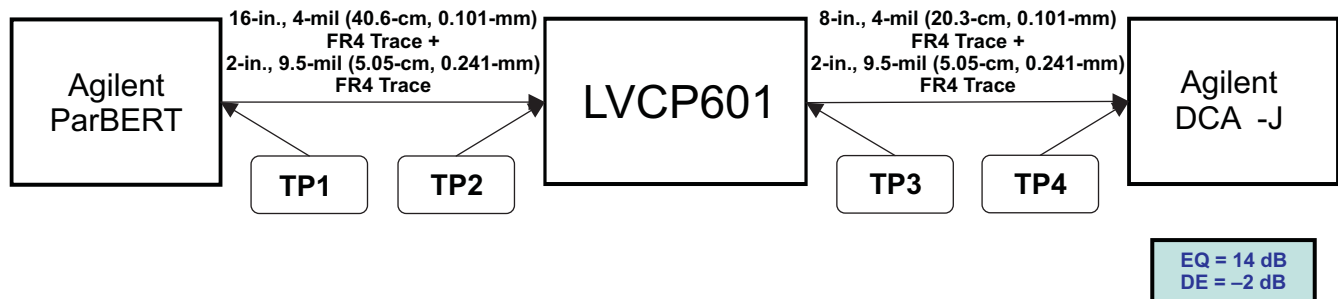

Figure 10. TX Differential Output De-Emphasis

SN75LVCP601 TYPICAL PERFORMANCE CURVE

- Input signal characteristics
 - Data rate = 6 Gbps, 3 Gbps, 1.5 Gbps
 - Amplitude = 500 mVp-p
 - Data pattern = K28.5
- SN75LVCP601 device setup
 - Temperature = 25°C
 - Voltage = 3.3 V
 - De-emphasis duration = 117 ps (short)
 - Equalization and de-emphasis set to optimize performance at 6 Gbps

With LVCP601



Without LVCP601

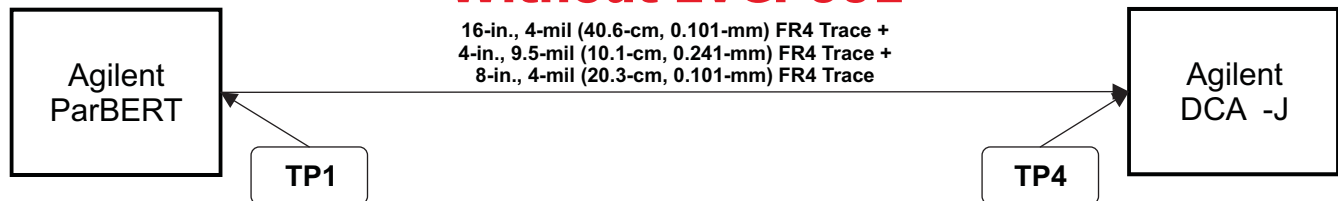

Figure 11. Performance Curve Measurement Setup

SN75LVCP601 TYPICAL PERFORMANCE CURVE (continued)

Test Point	TJ (1e-12) ps	DJ (δ-δ) ps	RJ (rms) ps	Eye Amplitude mV	Eye Width ps	Eye Opening mV	Eye Diagram
TP1	29.0	3.3	1.88	412.4	159.2	350.52	
TP2	91.8	65.4	1.93	240	28.9	81.24	
TP3	42.0	15.9	1.91	788.8	141.3	623.02	
TP4 With LVCP601	39.0	12.7	1.92	557.1	149.7	459.62	
TP4 Without LVCP601	56.7	29.8	2.00	165.4	101	13.24	

Figure 12. Jitter and VOD Results: Case 1 at 6 Gbps

Test Point	TJ (1e-12) ps	DJ (δ-δ) ps	RJ (rms) ps	Eye Amplitude mV	Eye Width ps	Eye Opening mV	Eye Diagram
TP1	29.7	3.8	1.89	430.9	326	392.84	
TP2	72.7	46.8	1.89	314.9	237	222.36	
TP3	39.6	12.8	1.96	714.5	321	611.62	
TP4 With LVCP601	47.9	20.3	1.99	615.3	305.0	463.42	
TP4 Without LVCP601	128.6	101.8	1.96	258.8	118	122.26	

Figure 13. Jitter and VOD Results: Case 2 at 3 Gbps

SN75LVCP601 TYPICAL PERFORMANCE CURVE (continued)

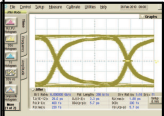
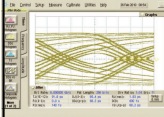
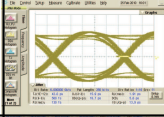
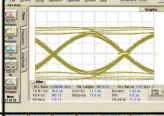
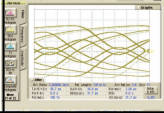
Test Point	TJ (1e-12) ps	DJ (δ-δ) ps	RJ (rms) ps	Eye Amplitude mV	Eye Width ps	Eye Opening mV	Eye Diagram
TP1	34.3	3.4	2.26	448	659	417.28	
TP2	67.5	38.6	2.11	363.4	589	318.48	
TP3	44.9	13.2	2.31	753.1	649	604.02	
TP4 With LVCP601	57.3	21.5	2.62	672.8	632.0	442.42	
TP4 Without LVCP601	113.3	81.9	2.30	322.8	493	217.46	

Figure 14. Jitter and VOD Results: Case 3 at 1.5 Gbps

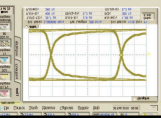
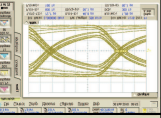
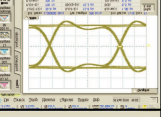
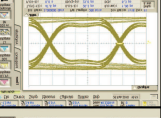
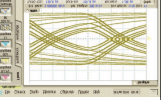
TYPICAL CHARACTERISTICS
RESIDUAL DJ AND EYE OPENING
vs
INPUT TRACE LENGTH

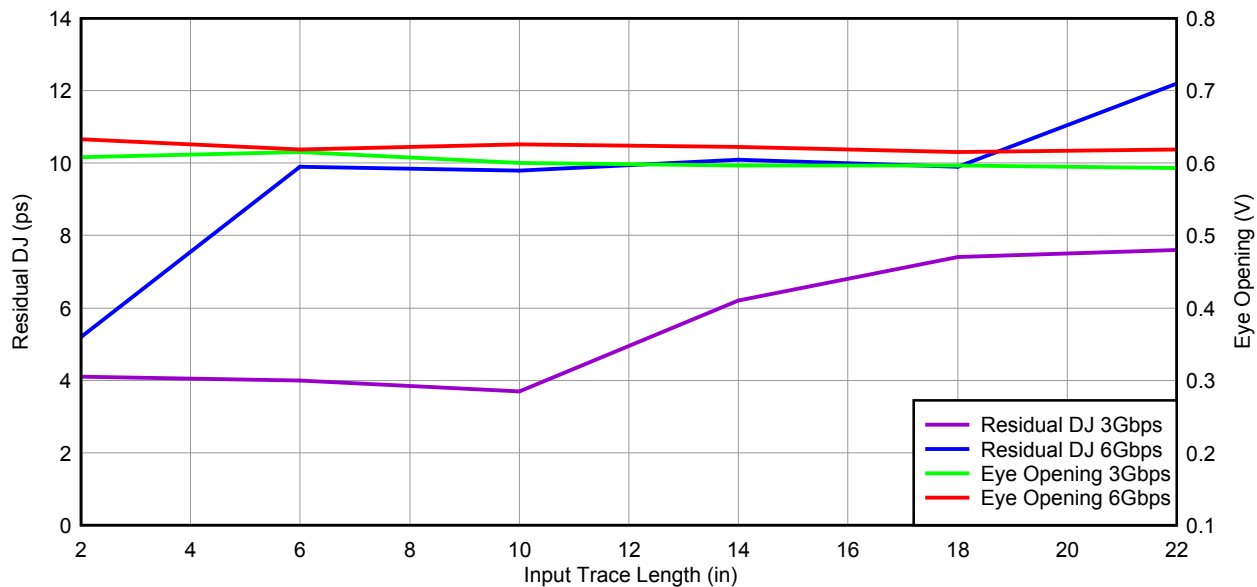
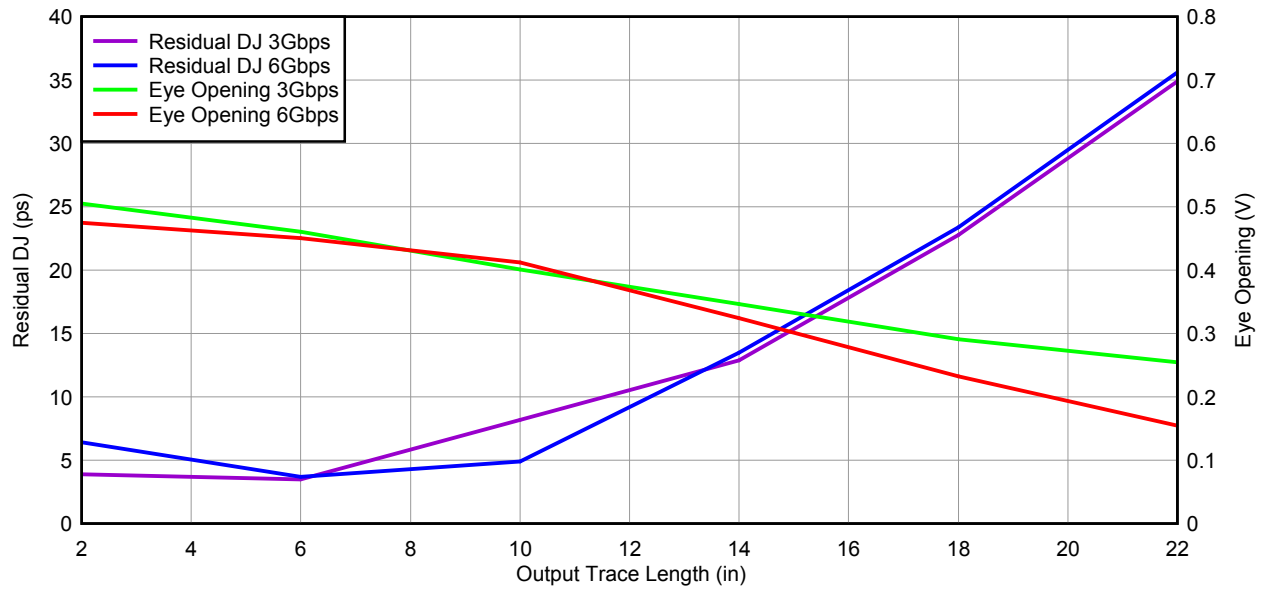

Figure 15.

G001

TYPICAL CHARACTERISTICS (continued)

**RESIDUAL DJ AND EYE OPENING
vs
OUTPUT TRACE LENGTH**



G002

Figure 16.

PACKAGING INFORMATION

Orderable Device	Status ⁽¹⁾	Package Type	Package Drawing	Pins	Package Qty	Eco Plan ⁽²⁾	Lead/ Ball Finish	MSL Peak Temp ⁽³⁾	Samples (Requires Login)
SN75LVCP601RTJR	ACTIVE	QFN	RTJ	20	3000	Green (RoHS & no Sb/Br)	Call TI	Level-2-260C-1 YEAR	
SN75LVCP601RTJT	ACTIVE	QFN	RTJ	20	250	Green (RoHS & no Sb/Br)	Call TI	Level-2-260C-1 YEAR	

⁽¹⁾ The marketing status values are defined as follows:

ACTIVE: Product device recommended for new designs.

LIFEBUY: TI has announced that the device will be discontinued, and a lifetime-buy period is in effect.

NRND: Not recommended for new designs. Device is in production to support existing customers, but TI does not recommend using this part in a new design.

PREVIEW: Device has been announced but is not in production. Samples may or may not be available.

OBsolete: TI has discontinued the production of the device.

⁽²⁾ Eco Plan - The planned eco-friendly classification: Pb-Free (RoHS), Pb-Free (RoHS Exempt), or Green (RoHS & no Sb/Br) - please check <http://www.ti.com/productcontent> for the latest availability information and additional product content details.

TBD: The Pb-Free/Green conversion plan has not been defined.

Pb-Free (RoHS): TI's terms "Lead-Free" or "Pb-Free" mean semiconductor products that are compatible with the current RoHS requirements for all 6 substances, including the requirement that lead not exceed 0.1% by weight in homogeneous materials. Where designed to be soldered at high temperatures, TI Pb-Free products are suitable for use in specified lead-free processes.

Pb-Free (RoHS Exempt): This component has a RoHS exemption for either 1) lead-based flip-chip solder bumps used between the die and package, or 2) lead-based die adhesive used between the die and leadframe. The component is otherwise considered Pb-Free (RoHS compatible) as defined above.

Green (RoHS & no Sb/Br): TI defines "Green" to mean Pb-Free (RoHS compatible), and free of Bromine (Br) and Antimony (Sb) based flame retardants (Br or Sb do not exceed 0.1% by weight in homogeneous material)

⁽³⁾ MSL, Peak Temp. -- The Moisture Sensitivity Level rating according to the JEDEC industry standard classifications, and peak solder temperature.

Important Information and Disclaimer: The information provided on this page represents TI's knowledge and belief as of the date that it is provided. TI bases its knowledge and belief on information provided by third parties, and makes no representation or warranty as to the accuracy of such information. Efforts are underway to better integrate information from third parties. TI has taken and continues to take reasonable steps to provide representative and accurate information but may not have conducted destructive testing or chemical analysis on incoming materials and chemicals. TI and TI suppliers consider certain information to be proprietary, and thus CAS numbers and other limited information may not be available for release.

In no event shall TI's liability arising out of such information exceed the total purchase price of the TI part(s) at issue in this document sold by TI to Customer on an annual basis.

TAPE AND REEL BOX DIMENSIONS

*All dimensions are nominal

Device	Package Type	Package Drawing	Pins	SPQ	Length (mm)	Width (mm)	Height (mm)
SN75LVCP601RTJR	QFN	RTJ	20	3000	346.0	346.0	29.0
SN75LVCP601RTJT	QFN	RTJ	20	250	190.5	212.7	31.8

RTJ (S-PWQFN-N20)

PLASTIC QUAD FLATPACK NO-LEAD

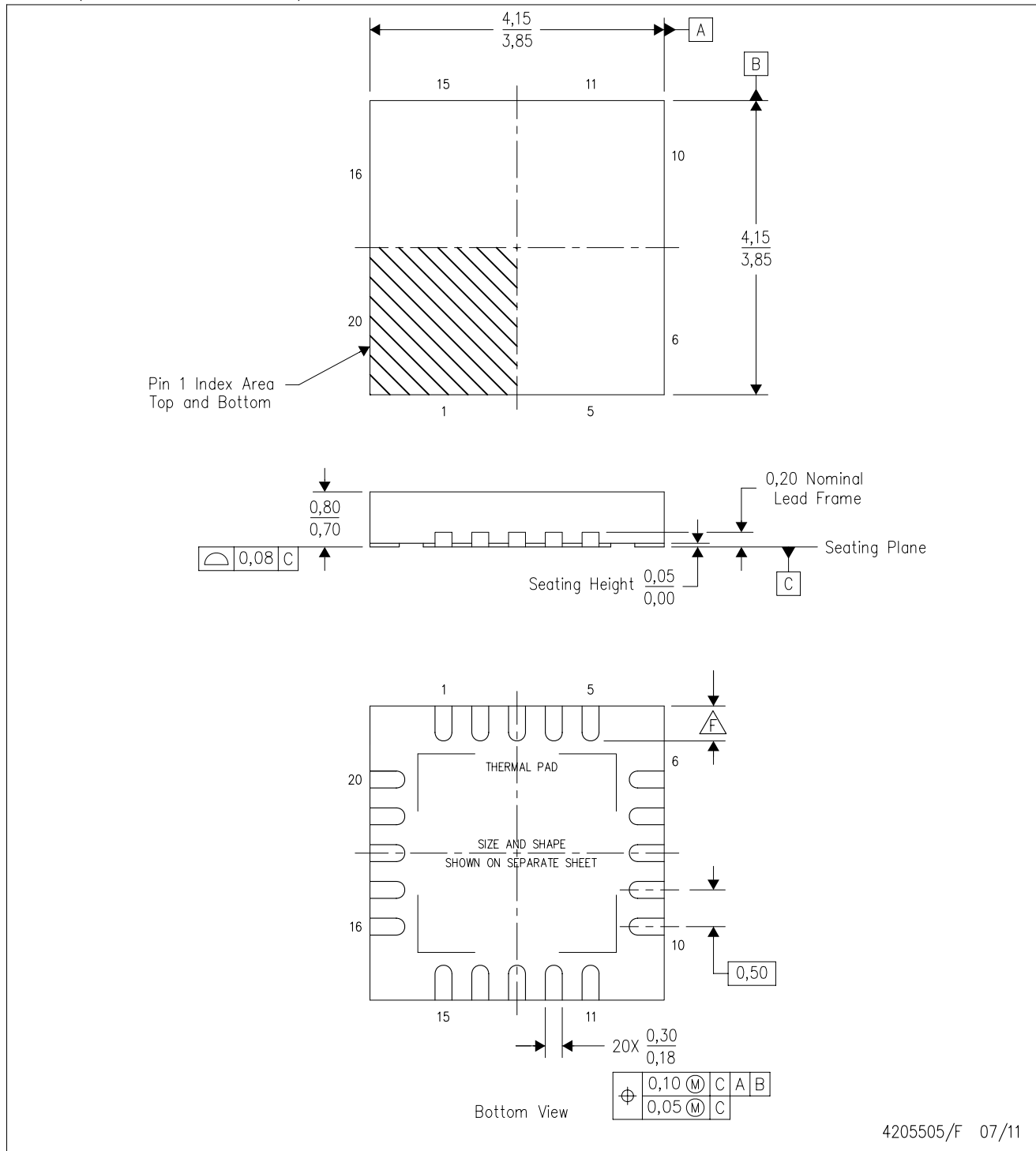

4205505/F 07/11

- NOTES:
- All linear dimensions are in millimeters. Dimensioning and tolerancing per ASME Y14.5-1994.
 - This drawing is subject to change without notice.
 - QFN (Quad Flatpack No-Lead) package configuration.
 - The package thermal pad must be soldered to the board for thermal and mechanical performance.
 - See the additional figure in the Product Data Sheet for details regarding the exposed thermal pad features and dimensions.
- ⚠ Check thermal pad mechanical drawing in the product datasheet for nominal lead length dimensions.

RTJ (S-PWQFN-N20)

PLASTIC QUAD FLATPACK NO-LEAD

THERMAL INFORMATION

This package incorporates an exposed thermal pad that is designed to be attached directly to an external heatsink. The thermal pad must be soldered directly to the printed circuit board (PCB). After soldering, the PCB can be used as a heatsink. In addition, through the use of thermal vias, the thermal pad can be attached directly to the appropriate copper plane shown in the electrical schematic for the device, or alternatively, can be attached to a special heatsink structure designed into the PCB. This design optimizes the heat transfer from the integrated circuit (IC).

For information on the Quad Flatpack No-Lead (QFN) package and its advantages, refer to Application Report, QFN/SON PCB Attachment, Texas Instruments Literature No. SLUA271. This document is available at www.ti.com.

The exposed thermal pad dimensions for this package are shown in the following illustration.

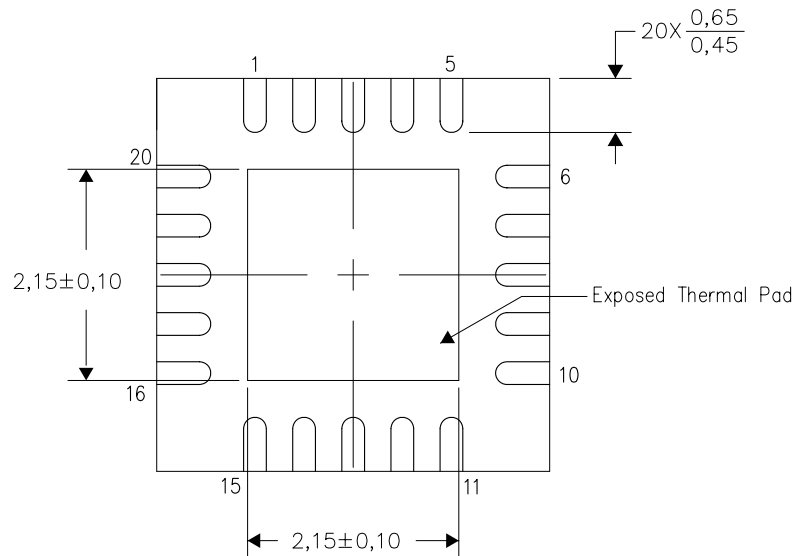

Bottom View

Exposed Thermal Pad Dimensions

4206256-3/Q 07/11

NOTE: All linear dimensions are in millimeters

RTJ (S-PWQFN-N20)

PLASTIC QUAD FLATPACK NO-LEAD

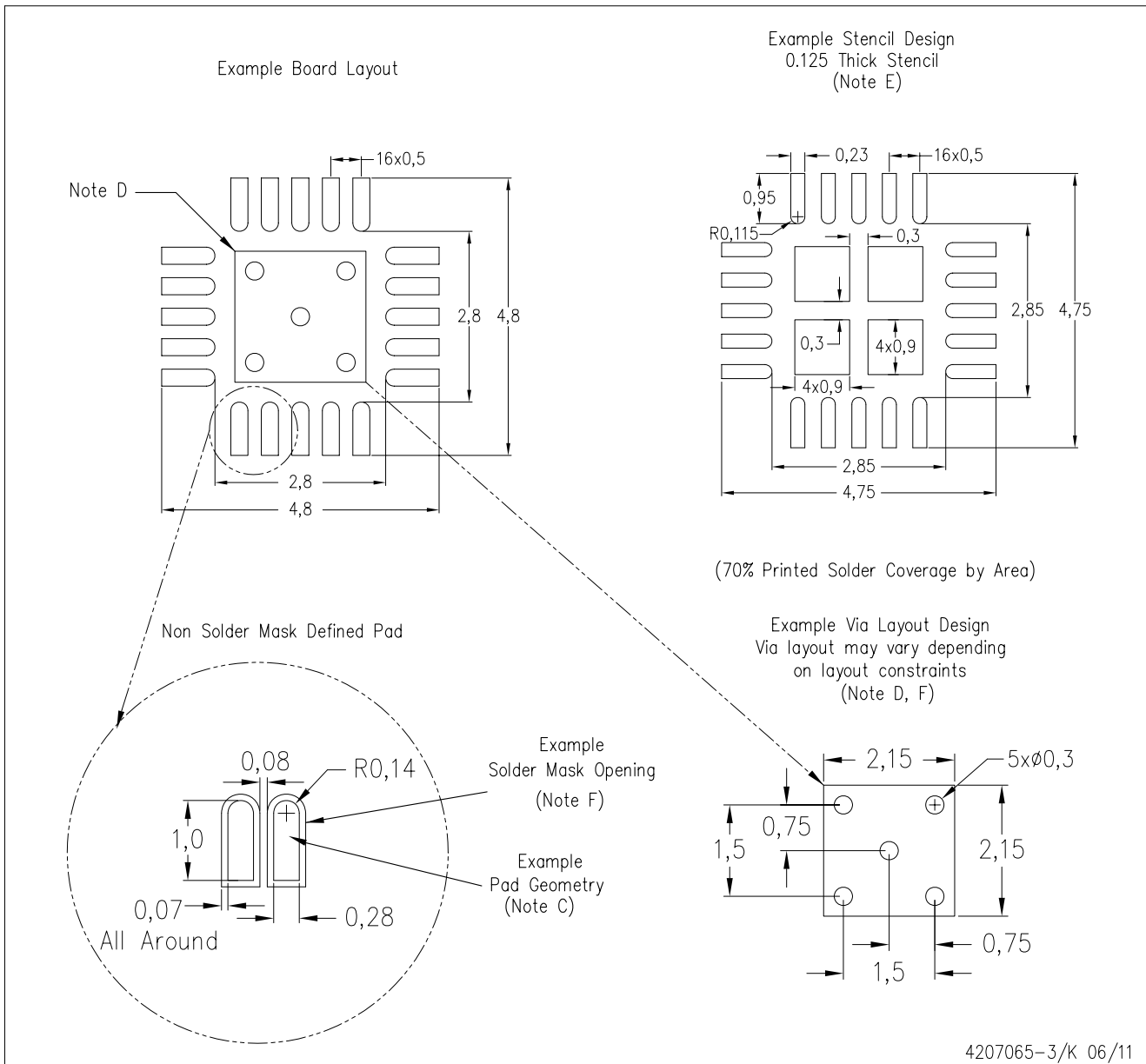

- NOTES:
- All linear dimensions are in millimeters.
 - This drawing is subject to change without notice.
 - Publication IPC-7351 is recommended for alternate designs.
 - This package is designed to be soldered to a thermal pad on the board. Refer to Application Note, Quad Flat-Pack Packages, Texas Instruments Literature No. SLUA271, and also the Product Data Sheets for specific thermal information, via requirements, and recommended board layout. These documents are available at www.ti.com <<http://www.ti.com>>.
 - Laser cutting apertures with trapezoidal walls and also rounding corners will offer better paste release. Customers should contact their board assembly site for stencil design recommendations. Refer to IPC 7525 for stencil design considerations.
 - Customers should contact their board fabrication site for recommended solder mask tolerances and via tenting recommendations for vias placed in the thermal pad.

IMPORTANT NOTICE

Texas Instruments Incorporated and its subsidiaries (TI) reserve the right to make corrections, modifications, enhancements, improvements, and other changes to its products and services at any time and to discontinue any product or service without notice. Customers should obtain the latest relevant information before placing orders and should verify that such information is current and complete. All products are sold subject to TI's terms and conditions of sale supplied at the time of order acknowledgment.

TI warrants performance of its hardware products to the specifications applicable at the time of sale in accordance with TI's standard warranty. Testing and other quality control techniques are used to the extent TI deems necessary to support this warranty. Except where mandated by government requirements, testing of all parameters of each product is not necessarily performed.

TI assumes no liability for applications assistance or customer product design. Customers are responsible for their products and applications using TI components. To minimize the risks associated with customer products and applications, customers should provide adequate design and operating safeguards.

TI does not warrant or represent that any license, either express or implied, is granted under any TI patent right, copyright, mask work right, or other TI intellectual property right relating to any combination, machine, or process in which TI products or services are used. Information published by TI regarding third-party products or services does not constitute a license from TI to use such products or services or a warranty or endorsement thereof. Use of such information may require a license from a third party under the patents or other intellectual property of the third party, or a license from TI under the patents or other intellectual property of TI.

Reproduction of TI information in TI data books or data sheets is permissible only if reproduction is without alteration and is accompanied by all associated warranties, conditions, limitations, and notices. Reproduction of this information with alteration is an unfair and deceptive business practice. TI is not responsible or liable for such altered documentation. Information of third parties may be subject to additional restrictions.

Resale of TI products or services with statements different from or beyond the parameters stated by TI for that product or service voids all express and any implied warranties for the associated TI product or service and is an unfair and deceptive business practice. TI is not responsible or liable for any such statements.

TI products are not authorized for use in safety-critical applications (such as life support) where a failure of the TI product would reasonably be expected to cause severe personal injury or death, unless officers of the parties have executed an agreement specifically governing such use. Buyers represent that they have all necessary expertise in the safety and regulatory ramifications of their applications, and acknowledge and agree that they are solely responsible for all legal, regulatory and safety-related requirements concerning their products and any use of TI products in such safety-critical applications, notwithstanding any applications-related information or support that may be provided by TI. Further, Buyers must fully indemnify TI and its representatives against any damages arising out of the use of TI products in such safety-critical applications.

TI products are neither designed nor intended for use in military/aerospace applications or environments unless the TI products are specifically designated by TI as military-grade or "enhanced plastic." Only products designated by TI as military-grade meet military specifications. Buyers acknowledge and agree that any such use of TI products which TI has not designated as military-grade is solely at the Buyer's risk, and that they are solely responsible for compliance with all legal and regulatory requirements in connection with such use.

TI products are neither designed nor intended for use in automotive applications or environments unless the specific TI products are designated by TI as compliant with ISO/TS 16949 requirements. Buyers acknowledge and agree that, if they use any non-designated products in automotive applications, TI will not be responsible for any failure to meet such requirements.

Following are URLs where you can obtain information on other Texas Instruments products and application solutions:

Products

Audio	www.ti.com/audio
Amplifiers	amplifier.ti.com
Data Converters	dataconverter.ti.com
DLP® Products	www.dlp.com
DSP	dsp.ti.com
Clocks and Timers	www.ti.com/clocks
Interface	interface.ti.com
Logic	logic.ti.com
Power Mgmt	power.ti.com
Microcontrollers	microcontroller.ti.com
RFID	www.ti-rfid.com
RF/IF and ZigBee® Solutions	www.ti.com/lprf

Applications

Communications and Telecom	www.ti.com/communications
Computers and Peripherals	www.ti.com/computers
Consumer Electronics	www.ti.com/consumer-apps
Energy and Lighting	www.ti.com/energy
Industrial	www.ti.com/industrial
Medical	www.ti.com/medical
Security	www.ti.com/security
Space, Avionics and Defense	www.ti.com/space-avionics-defense
Transportation and Automotive	www.ti.com/automotive
Video and Imaging	www.ti.com/video
Wireless	www.ti.com/wireless-apps

TI E2E Community Home Page

e2e.ti.com

Mailing Address: Texas Instruments, Post Office Box 655303, Dallas, Texas 75265
Copyright © 2011, Texas Instruments Incorporated